

**COSO**®

**GERMAN** HEALTH  
BATHROOM

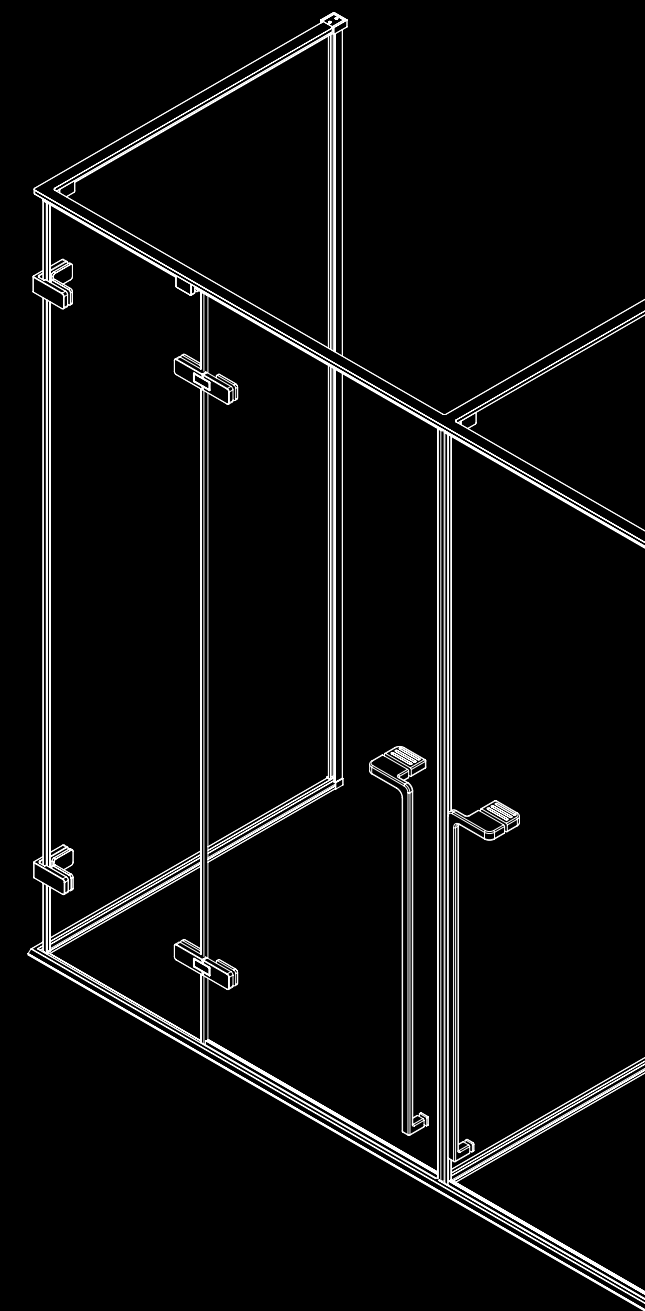

德国总部 COSO Technologie Deutschland GmbH  
Am Wasserfall 1 DE-51570 Windeck-schladem Germany  
+49(0)5118973-798  
www.coso-global.com

德国 COSO 科技公司  
中国·COSO 高斯·营销管理中心  
佛山市顺德区杏坛镇德进路3号  
400-882-1238  
www.coso.cn

**COSO**®



**GERMAN**

health

bathroom



COSO takes the German industrial standards as the design theory, producing the most logical and beautiful products by high quality material, ergonomics, mathematical space, rigorous manufacturing and rational beauty.





An aerial view of a city, likely Regensburg, Germany, featuring a river, a suspension bridge, and various buildings. The text 'COSO GERMAN INDUSTRIAL' is overlaid in large white letters.

# COSO GERMAN INDU- STRIAL

An aerial view of a castle with multiple towers and spires, situated on a hill overlooking a city. The text 'COSO TAKES THE GERMAN INDUSTRIAL STANDARDS AS THE DESIGN THEORY, PRODUCING THE MOST LOGICAL AND BEAUTIFUL PRODUCTS BY HIGH QUALITY MATERIAL, ERGONOMICS, MATHEMATICAL SPACE, RIGOROUS MANUFACTURING AND RATIONAL BEAUTY.' is overlaid in white letters.

COSO TAKES THE GERMAN INDUSTRIAL STANDARDS AS THE DESIGN THEORY, PRODUCING THE MOST LOGICAL AND BEAUTIFUL PRODUCTS BY HIGH QUALITY MATERIAL, ERGONOMICS, MATHEMATICAL SPACE, RIGOROUS MANUFACTURING AND RATIONAL BEAUTY.

**BECOME THE SYNONYM OF  
HEALTH, PRACTICABILITY,  
RATIONALITY AND SUBSTANTIAL.**





# SPACE AND DREAMS

# DESIGN CONCEPT

## 艺术：源于生活，创造非凡

对于唯美的创造，永远不能用“事物”这个普通的词语来定义，恒久品质，品味非凡，高斯的每一件产品俨然是无与伦比的艺术品！

突破日常的功能性用途，高斯人为这些艺术品塑造出众的外形，赋予他们丰富的文化内涵，让他们成为独立的个体而存在；甚至，由于承载着主人的某种情感而拥有灵魂和生命。

所有这一切，归因于我们日常看起来最平常不过的情景——生活

源于生活，让高斯的设计理念能深入人心，自然和谐。

高于生活，让高斯的设计理念能走得更远，为人们描绘未来生活的图画。

一花一世界，是生活提供了我们设计的灵感和素材，赋予我们创造非凡的机会！

Creation of aestheticism can never be defined by the common word "Things".With everlasting quality and extraordinary taste, each every product of COSO just likes an artwork that is incomparable!

Breaking through the daily functional purposes,COSOs' created outstanding appearance for these artworks,and gave them rich cultural connotations,so that they exist as independent individual,furthermore,they own soul and life by carrying some kind of emotions of the owner.

All of this owes to the most common scene day to day-life.

Originating form life makes design concept of COSO deep inside the heart,naturally and harmoniously.

Higher than life makes design concept of COSO going further to draw a picture of people's future life.

The flowers and the word is the inspiration and material that life provide to us and gave us the opportunity to create extraordinary!

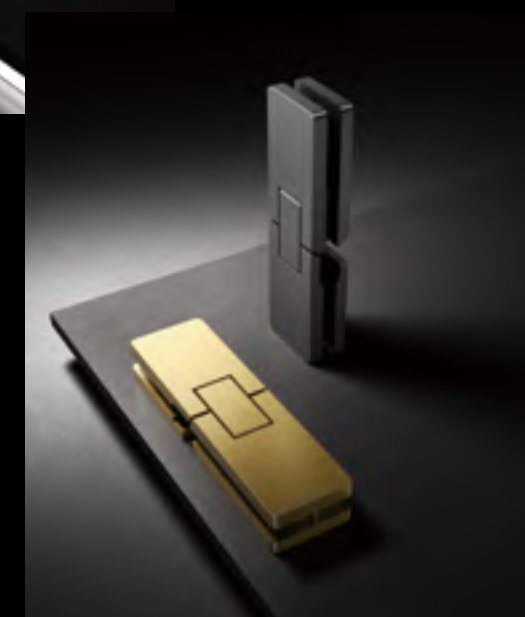
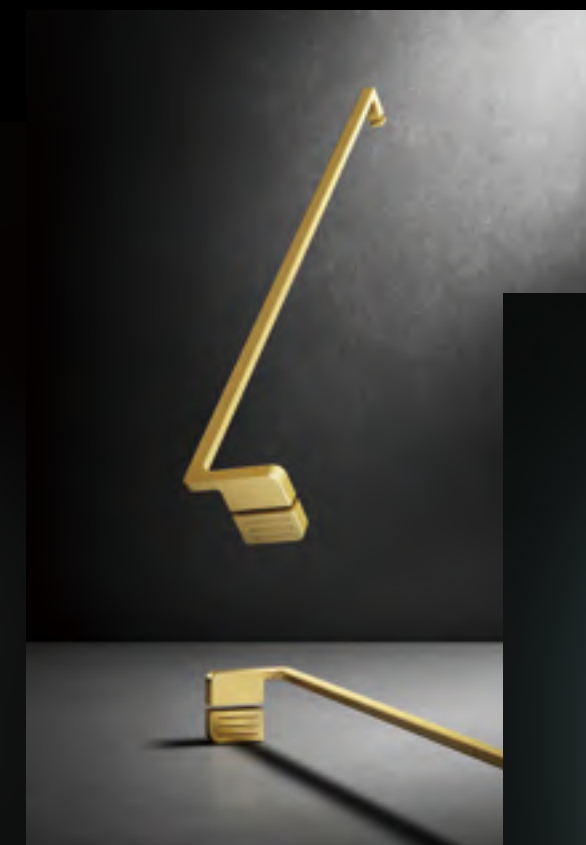



# MATERIAL AND APPEARANCE

1.2mm  
10K

不锈钢型材 / Stainless steel sectional material

304# 不锈钢触感硬朗，富浓烈的金属质感，是一种十分前卫时尚的淋浴房材料。1.2mm 以上加厚设计，承重力极佳，不易变形，耐腐蚀性强。完美展现精磨的 10K 镜面效果，持久光亮如新！

SS304 has a tough sense of touch and strong metallic texture, so it is a kind of advanced and fashion material for the shower room. It is designed with the thickness over than 1.2mm, which enables it with excellent bearing capacity, nondeformed performance and strong erosion-proof ability. It will exhibit the perfect 10K mirror effect after fine grinding and keep always bright.



折弯型材工艺  
Bending technology

行业独有的折弯型材工艺，坚实耐用，美观大方。

The particular bending technology in the industry will make the shower room solid, durable and elegant.



无框推拉专利  
Rimless push-and-pull proprietary

无框推拉设计，摆脱边框色彩的束缚，更易搭配，整体观感更加通透美观。

The rimless push-and-pull design will get rid of the constraint of the colored frames. So they are easier to match and it looks to be more transparent and beautiful in the entire impression.



精品置物架  
Delicate commodity shelf

精品置物架，内外可用，时尚、方便！满足充满个性需求的您！

The delicate commodity shelf can be used both inside and outside. It is fashion, convenient and it can reach your individual requirements.



顺柔转轴技术  
Flexible spindle technology

通过 250 万次机械开闭测试，确保开合柔和顺畅，使用寿命长久。

It has gone through the mechanical lockage test of 2500000 to make sure that the spindle has flexible opening and closing as well as long service life.

COPPER >20%  
10mm

铝合金型材 / Aluminum alloy extrusions

高斯淋浴房所采用铝合金硬度为 12 度左右，是由高纯铝锭（含铁量 < 0.1%）配方，其中铜含量较普通铝锭高出 20% 以上，从而彰显出氧化处理后的高亮度表面的质感及饱满、均匀的色泽感。高斯淋浴房的铝材壁厚设计一般在（1.0-4.0mm），特殊部位甚至达到 10mm，因此，承载力强，不易变形。

The hardness of the aluminum alloy used for COSO shower room is about 12 degree. It is formulated by aluminum ingot with high purity iron content < 0.1%. Its copper content is over 20% higher than normal aluminum ingot, so as to show the texture and the rich, smooth lustre of the high-light surface after the oxidation treatment. The wall thickness of the aluminum material for COSO shower room is usually designed within 1.0-4.0mm, and even 10mm in some special parts. Therefore, it has a high bearing capacity and it is not easy to get deformed.



轨道与边柱调节  
The adjusting function of the railway and side column

轨道与边柱之间可以伸缩调节，免除墙壁不垂直造成有缝隙的缺陷，使安装更简便。

It is adjustable between the railway and side column to eliminate the defects of cracks caused by non-normal wall. It is also much easier to install the shower room.



外装合页  
Exterior hinge

人性化外装合页设计，保证淋浴房内部平整，让清洁变得更加轻松快捷。

The humanized exterior hinge will ensure the interior leveling of the shower room, thus making clean easier and faster.



墙夹纵横调节  
The vertical and horizontal adjusting function of the wall clip

墙夹可纵横调节，修正墙面施工误差，实现淋浴房的最佳使用状态。

The wall clip can be adjusted vertically and horizontally to amend the construction errors on the wall, so that the shower room will be able to present the best condition.



FASHIPNABLE  
LANGUAGE.

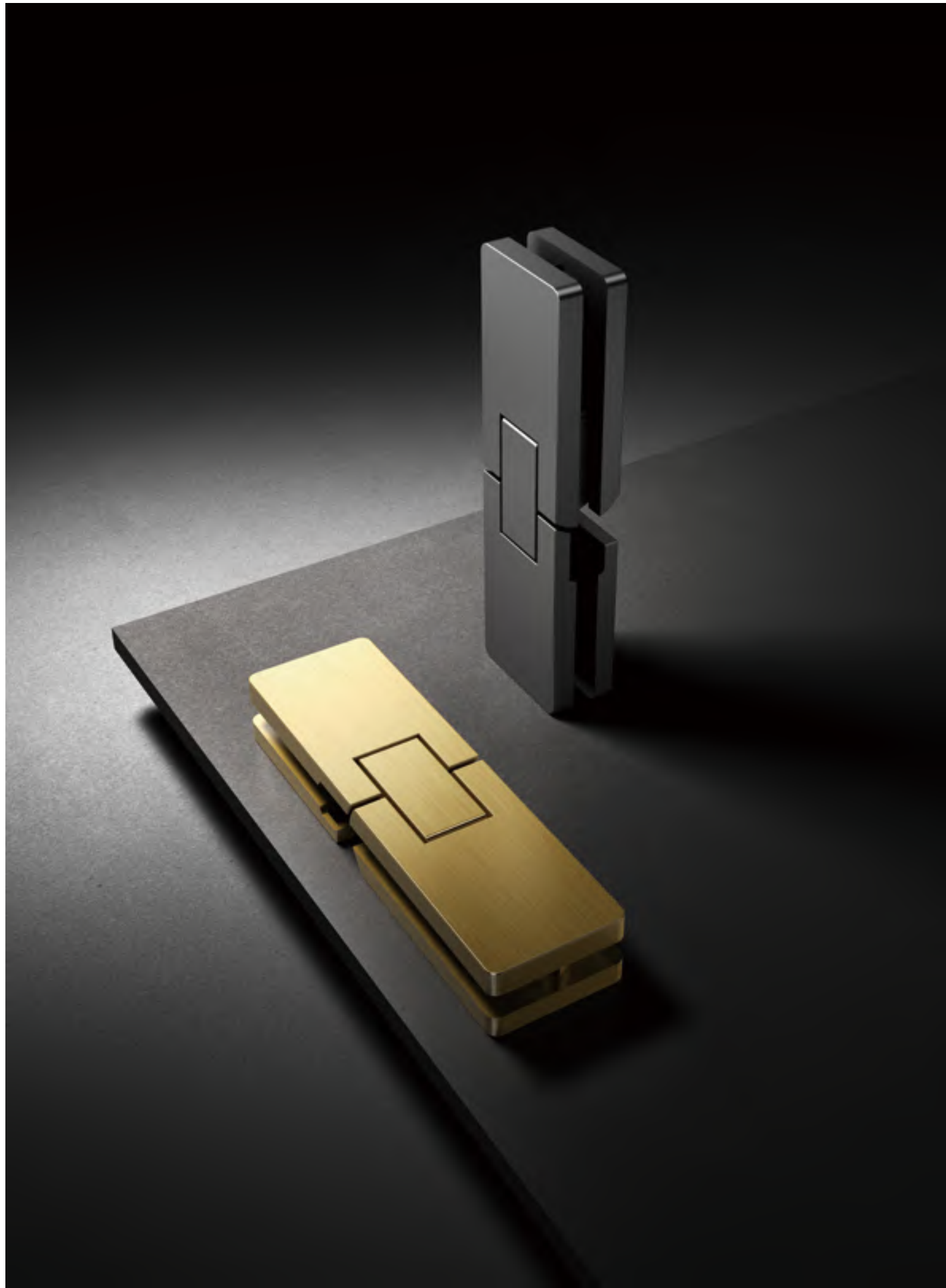

Classic artwork inspires the heart. resplendent and unique design together with excellent techniques strikes the heart, and perfectly interprets aesthetic feeling. it is really the perfect combination of creativity and technology.



# E1 SERIES



E1T52A



E1 SERIES

**GERMAN** HEALTH BATHROOM.



BEYOND ALL BOUNDARIES, THE GERMAN SHOWER ROOM TO THE EXTREME. TELL ITS STORY, AROUSE THE EMOTIONAL IMPACT OF COLOR.

E1431LA





E1331RB

COMFORT AND NATURE COME FROM COUNTLESS TECHNICAL  
SUBLIMATION, SCIENCE AND AESTHETICS HARMONIOUSLY INTEGRATE, AND  
HEALTHY LIFE COMES FROM ULTIMATE PERFECTION.



E1131LB



Glass thickness 10mm Material Stainless steel  
玻璃厚度 10mm 材质 不锈钢

Color Mirror polish/Matte black/Brush gun grey /Brushed titanium  
颜色 镜光/雅黑/拉丝枪灰/拉丝钛金

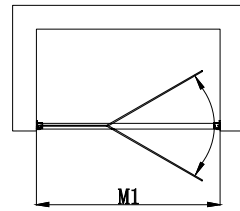
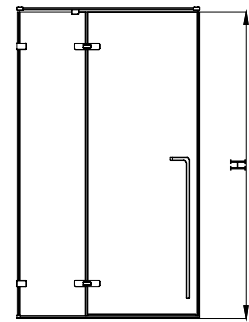

## E1121LA(墙夹)

Opening method	One-fixed-one-movable shaft (left inside and outside open)	
开门方式	一固一活开门(左内外开)	
Standard of size	M1=1000	H=2100
标准尺寸	宽1=1000	高=2100
Size range	M1=900-1400	H=1900-2400
定做范围	宽1=900-1400	高=1900-2400

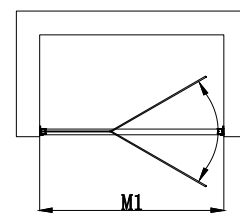
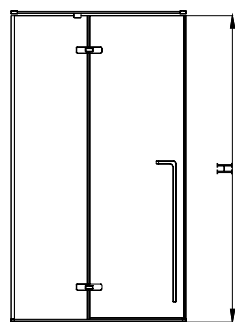

## E1121LB(边材)

Opening method	One-fixed-one-movable shaft (left inside and outside open)	
开门方式	一固一活开门(左内外开)	
Standard of size	M1=1000	H=2100
标准尺寸	宽1=1000	高=2100
Size range	M1=900-1400	H=1900-2400
定做范围	宽1=900-1400	高=1900-2400

Glass thickness 10mm Material Stainless steel  
玻璃厚度 10mm 材质 不锈钢

Color Mirror polish/Matte black/Brush gun grey /Brushed titanium  
颜色 镜光/雅黑/拉丝枪灰/拉丝钛金

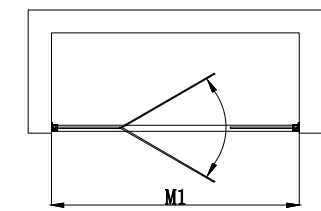
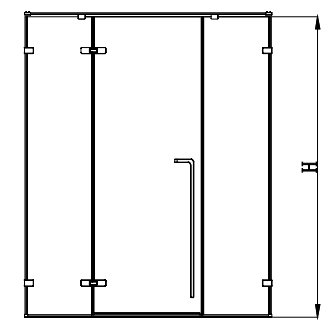

## E1131LA(墙夹)

Opening method	Two-fixed-one-movable door (left inside and outside open)	
开门方式	两固一活开门(左内外开)	
Standard of size	M1=1500	H=2100
标准尺寸	宽1=1500	高=2100
Size range	M1=1200-2000	H=1900-2400
定做范围	宽1=1200-2000	高=1900-2400

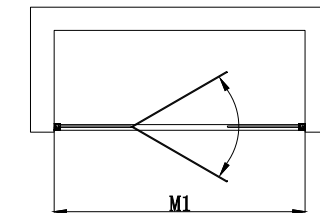
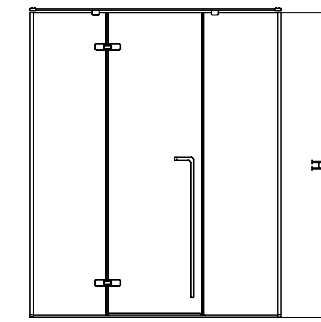

## E1131LB(边材)

Opening method	Two-fixed-one-movable door (left inside and outside open)	
开门方式	两固一活开门(左内外开)	
Standard of size	M1=1500	H=2100
标准尺寸	宽1=1500	高=2100
Size range	M1=1200-2000	H=1900-2400
定做范围	宽1=1200-2000	高=1900-2400

Glass thickness 10mm  
玻璃厚度 10mm

Material Stainless steel  
材质 不锈钢

Color Mirror polish/Matte black/Brush gun grey /Brushed titanium  
颜色 镜光/雅黑/拉丝枪灰/拉丝钛金

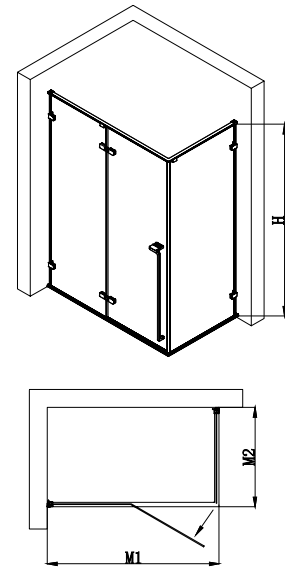

### E1331LA (墙夹)

Opening method	Rectangular door (left open)		
开门方式	长方形开门 (左外开)		
Standard of size	M1=1200	M2=900	H=2100
标准尺寸	宽1=1200	宽2=900	高=2100
Size range	M1=1000-1600	M2=800-1300	H=1900-2400
定做范围	M1=1000-1600	M2=800-1300	H=1900-2400

Glass thickness 10mm  
玻璃厚度 10mm

Material Stainless steel  
材质 不锈钢

Color Mirror polish/Matte black/Brush gun grey /Brushed titanium  
颜色 镜光/雅黑/拉丝枪灰/拉丝钛金

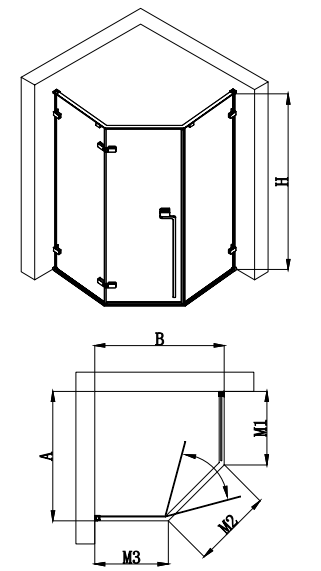

### E1431LA (墙夹)

Opening method	Diamond type flat opening (Open inside and outside)			
开门方式	钻石型开门 (内外开)			
Standard of size	M1=550	M2=636	M3=550	H=2100
标准尺寸	宽1=550	宽2=636	宽3=550	高=2100
Size range	M1=200-1300	M2=500-900	M3=200-1300	H=1900-2400
定做范围	宽1=200-1300	宽2=500-900	宽3=200-1300	高=1900-2400

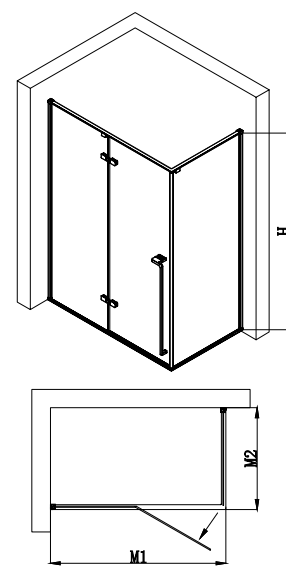

### E1331LB (边材)

Opening method	Rectangular door (left direction)		
开门方式	长方形开门 (左外开)		
Standard of size	M1=1200	M2=900	H=2100
标准尺寸	宽1=1200	宽2=900	高=2100
Size range	M1=1000-1600	M2=800-1300	H=1900-2400
定做范围	M1=1000-1600	M2=800-1300	H=1900-2400

### E1431LB (边材)

Opening method	Diamond-shaped shaft (Open inside and outside)			
开门方式	钻石型开门 (内外开)			
Standard of size	M1=550	M2=636	M3=550	H=2100
标准尺寸	宽1=550	宽2=636	宽3=550	高=2100
Size range	M1=200-1300	M2=500-900	M3=200-1300	H=1900-2400
定做范围	宽1=200-1300	宽2=500-900	宽3=200-1300	高=1900-2400

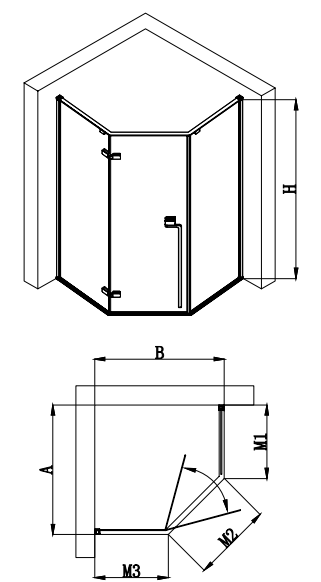



Glass thickness 10mm  
玻璃厚度 10mm

Material Stainless steel  
材质 不锈钢

Color Mirror polish/Matte black/Brush gun grey /Brushed titanium  
颜色 镜光/雅黑/拉丝枪灰/拉丝钛金

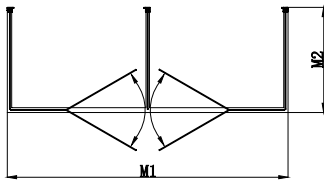
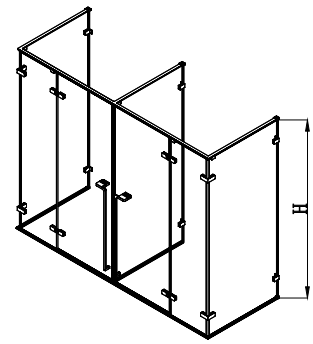

### E1E72A(墙夹)

Opening method	E type flat opening		
开门方式	“E”形开门		
Standard of size	M1= 2400	M2=1000	H=2200
标准尺寸	长 = 2400	宽=1000	高=2200
Size range	M1=2000-3000	M2=800-1500	H=1900-2400
定做范围	长 =2000-3000	宽 =800-1500	高=1900-2400

Glass thickness 10mm  
玻璃厚度 10mm

Material Stainless steel  
材质 不锈钢

Color Mirror polish/Matte black/Brush gun grey /Brushed titanium  
颜色 镜光/雅黑/拉丝枪灰/拉丝钛金

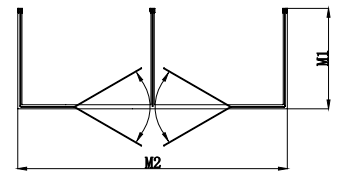
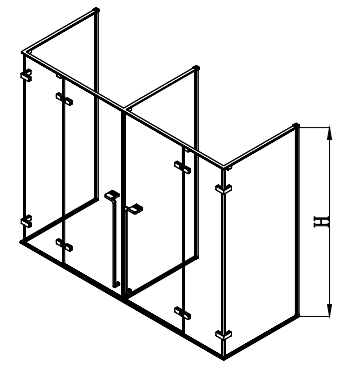

### E1E72B(边材)

Opening method	E type flat opening		
开门方式	“E”形开门		
Standard of size	M1= 2400	M2=1000	H=2200
标准尺寸	长 = 2400	宽=1000	高=2200
Size range	M1=2000-3000	M2=800-1500	H=1900-2400
定做范围	长 =2000-3000	宽 =800-1500	高=1900-2400

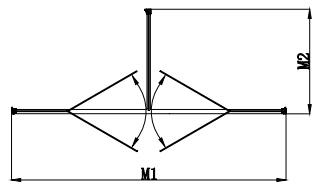
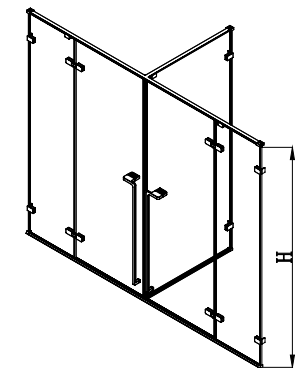

### E1T52A(墙夹)

Opening method	T type flat opening		
开门方式	“T”形开门		
Standard of size	M1= 2400	M2=1000	H=2200
标准尺寸	长 = 2400	宽=1000	高=2200
Size range	M1=2000-3000	M2=800-1500	H=1900-2400
定做范围	长 =2000-3000	宽 =800-1500	高=1900-2400

### E1T52B(边材)

Opening method	T type flat opening		
开门方式	“T”形开门		
Standard of size	M1= 2400	M2=1000	H=2200
标准尺寸	长 = 2400	宽=1000	高=2200
Size range	M1=2000-3000	M2=800-1500	H=1900-2400
定做范围	长 =2000-3000	宽 =800-1500	高=1900-2400

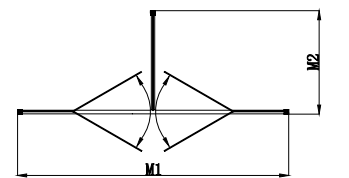
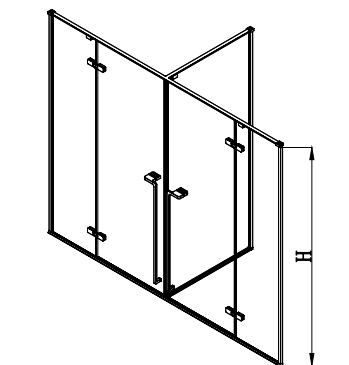



# DELICATE CARVING



# E2 SERIES

**GERMAN** HEALTH  
BATHROOM.

E2331LB



E2431LB

THE LINES THAT PAY ATTENTION TO THE SMALLEST DETAIL ARE VERY FORMAL AND EXQUISITE, AND ARE MADE OF THE HIGHEST QUALITY MATERIALS.



E2T52B



E2121LB

THE SLOW LIFE STYLE FULL OF ARTISTIC ARBITRARINESS MAKES THE GERMAN UNDERSTAND THE IMPORTANCE OF GOOD THINGS IN LIFE. SURROUNDED BY EXQUISITE AND MAGNIFICENT BUILDINGS, FAMOUS PAINTINGS WITH DIFFERENT STYLES, BRIGHT JEWELRY AND VALUABLE LUXURY CARS... SURROUNDED BY THESE BEAUTIFUL AND EXQUISITE ENVIRONMENT, THEY CULTIVATE THEIR AESTHETIC ABILITY AND TEMPERAMENT.

Glass thickness 10mm  
玻璃厚度 10mm

Material Stainless steel  
材质 不锈钢

Color Mirror polish/Matte black/Brush gun grey /Brushed titanium  
颜色 镜光/雅黑/拉丝枪灰/拉丝钛金

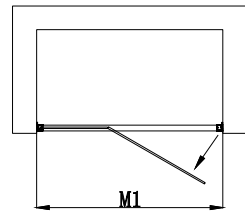
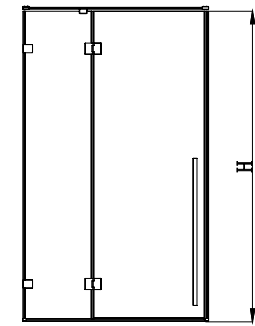

## E2121LA(墙夹)

Opening method	Glass tOne-fixed-one-movable shaft (left inside and outside open)	
开门方式	一固一活开门(左方向)	
Standard of size	M1=1000	H=2100
标准尺寸	宽1=1000	高=2100
Size range	M1=900-1400	H=1900-2400
定做范围	宽1=900-1400	高=1900-2400

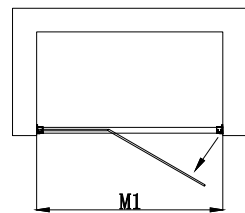
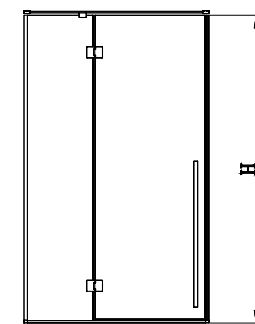

## E2121LB(边材)

Opening method	One-fixed-one-movable shaft (left inside and outside open)	
开门方式	一固一活开门(左方向)	
Standard of size	M1=1000	H=2100
标准尺寸	宽1=1000	高=2100
Size range	M1=900-1400	H=1900-2400
定做范围	宽1=900-1400	高=1900-2400

Glass thickness 10mm  
玻璃厚度 10mm

Material Stainless steel  
材质 不锈钢

Color Mirror polish/Matte black/Brush gun grey /Brushed titanium  
颜色 镜光/雅黑/拉丝枪灰/拉丝钛金

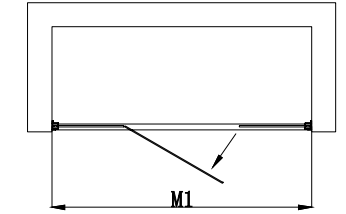
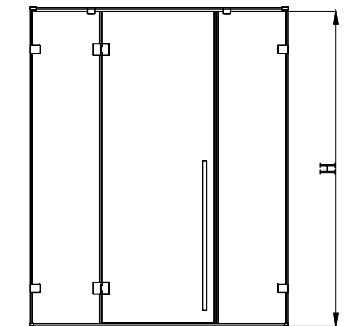

## E2131LA(墙夹)

Opening method	Two-fixed-one-movable door (left inside and outside open)	
开门方式	两固一活开门(左方向)	
Standard of size	M1=1500	H=2100
标准尺寸	宽1=1500	高=2100
Size range	M1=1200-2000	H=1900-2400
定做范围	宽1=1200-2000	高=1900-2400

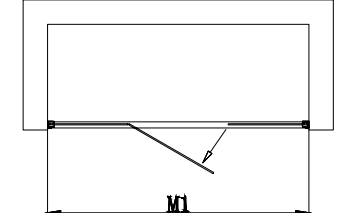
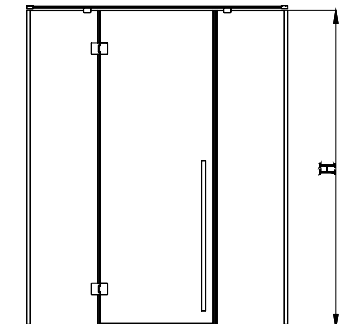

## E2131LB(边材)

Opening method	Two-fixed-one-movable door (left inside and outside open)	
开门方式	两固一活开门(左方向)	
Standard of size	M1=1500	H=2100
标准尺寸	宽1=1500	高=2100
Size range	M1=1200-2000	H=1900-2400
定做范围	宽1=1200-2000	高=1900-2400



Glass thickness 10mm  
玻璃厚度 10mm

Material Stainless steel  
材质 不锈钢

Color Mirror polish/Matte black/Brush gun grey/Brushed titanium  
颜色 镜光/雅黑/拉丝枪灰/拉丝钛金

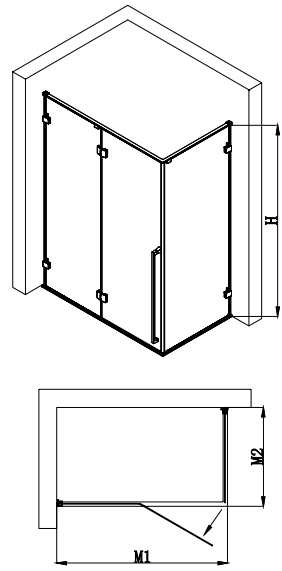

### E2331LA(墙夹)

Opening method	Rectangular door (left direction)		
开门方式	长方形开门(左方向)		
Standard of size	M1=1200	M2=900	H=2100
标准尺寸	宽1=1200	宽2=900	高=2100
Size range	M1=1000-1600	M2=800-1300	H=1900-2400
定做范围	宽1=1000-1600	宽2=800-1300	高=1900-2400

Glass thickness 10mm  
玻璃厚度 10mm

Material Stainless steel  
材质 不锈钢

Color Mirror polish/Matte black/Brush gun grey/Brushed titanium  
颜色 镜光/雅黑/拉丝枪灰/拉丝钛金

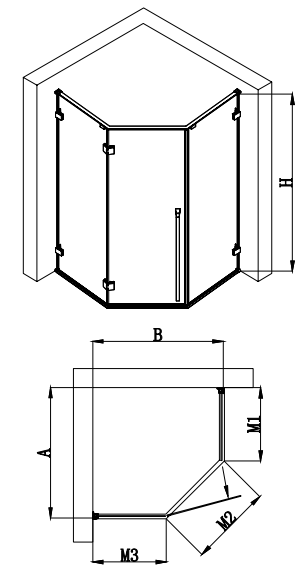

### E2431LA(墙夹)

Opening method	Diamond-shaped door (left direction)			
开门方式	钻石型开门(左方向)			
Standard of size	M1=550	M2=636	M3=550	H=2100
标准尺寸	宽1=550	宽2=636	宽3=550	高=2100
Size range	M1=200-1300	M2=500-900	M3=200-1300	H=1900-2400
定做范围	宽1=200-1300	宽2=500-900	宽3=200-1300	高=1900-2400

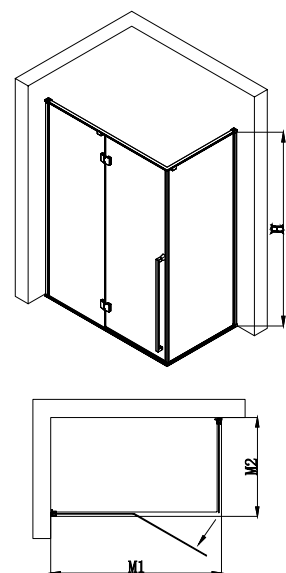

### E2331LB(边材)

Opening method	Rectangular door (left direction)		
开门方式	长方形开门(左方向)		
Standard of size	M1=1200	M2=900	H=2100
标准尺寸	宽1=1200	宽2=900	高=2100
Size range	M1=1000-1600	M2=800-1300	H=1900-2400
定做范围	宽1=1000-1600	宽2=800-1300	高=1900-2400

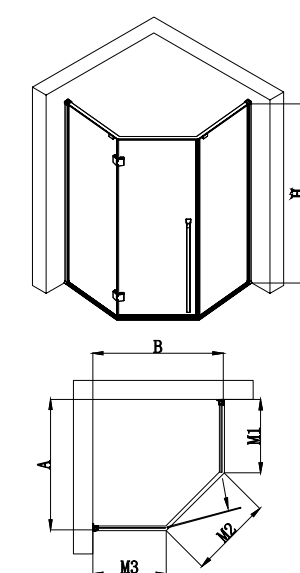

### E2431LB(边材)

Opening method	Diamond-shaped door (left direction)			
开门方式	钻石型开门(左方向)			
Standard of size	M1=550	M2=636	M3=550	H=2100
标准尺寸	宽1=550	宽2=636	宽3=550	高=2100
Size range	M1=200-1300	M2=500-900	M3=200-1300	H=1900-2400
定做范围	宽1=200-1300	宽2=500-900	宽3=200-1300	高=1900-2400

# E2E

Glass thickness 10mm 玻璃厚度 10mm  
 Material Stainless steel 材质 不锈钢  
 Color Mirror polish/Matte black/Brush gun grey/Brushed titanium 颜色 镜光/雅黑/拉丝枪灰/拉丝钛金

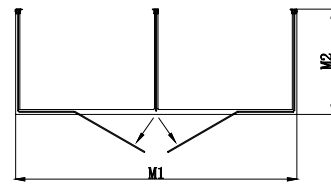
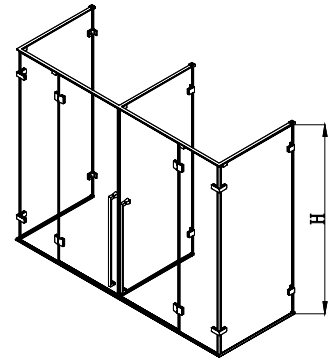

## E2E72A (墙夹)

Opening method 开门方式	"E" shaped door "E" 形开门		
Standard of size 标准尺寸	M1=2400 宽1=2400	M2=1000 宽2=1000	H=2200 高=2200
Size range 定做范围	M1=2000-3000 宽1=2000-3000	M2=800-1500 宽2=800-1500	H=1900-2400 高=1900-2400

# E2T

Glass thickness 10mm 玻璃厚度 10mm  
 Material Stainless steel 材质 不锈钢  
 Color Mirror polish/Matte black/Brush gun grey/Brushed titanium 颜色 镜光/雅黑/拉丝枪灰/拉丝钛金

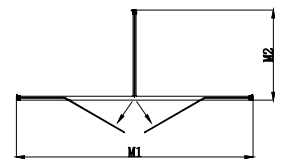
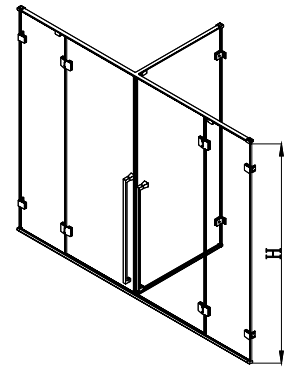

## E2T52A (墙夹)

Opening method 开门方式	"T" shaped door "T" 形开门		
Standard of size 标准尺寸	M1=2400 宽1=2400	M2=1000 宽2=1000	H=2200 高=2200
Size range 定做范围	M1=2000-3000 宽1=2000-3000	M2=800-1500 宽2=800-1500	H=1900-2400 高=1900-2400

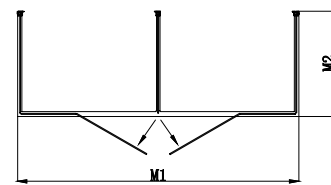
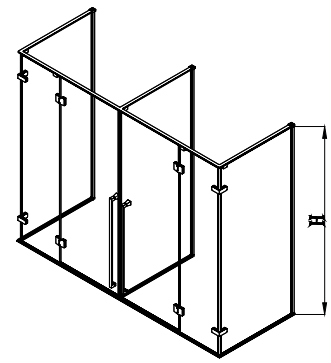

## E2E72B (边材)

Opening method 开门方式	"E" shaped door "E" 形开门		
Standard of size 标准尺寸	M1=2400 宽1=2400	M2=1000 宽2=1000	H=2200 高=2200
Size range 定做范围	M1=2000-3000 宽1=2000-3000	M2=800-1500 宽2=800-1500	H=1900-2400 高=1900-2400

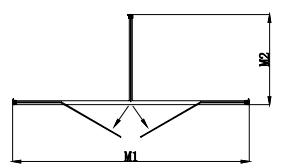
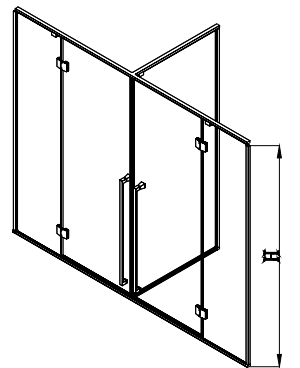

## E2T52B (边材)

Opening method 开门方式	"T" shaped door "T" 形开门		
Standard of size 标准尺寸	M1=2400 宽1=2400	M2=1000 宽2=1000	H=2200 高=2200
Size range 定做范围	M1=2000-3000 宽1=2000-3000	M2=800-1500 宽2=800-1500	H=1900-2400 高=1900-2400



# ULTIMATE PERFECTION.

COMFORT AND NATURE COME FROM COUNTLESS TECHNICAL SUBLIMATION, SCIENCE AND AESTHETICS HARMONIOUSLY INTEGRATE, AND HEALTHY LIFE COMES FROM ULTIMATE PERFECTION.







# D1 SERIES

**GERMAN** HEALTH BATHROOM.

D1331L



D1431L

SPACE INHERITS LIFE.  
DESIGN IS NOT ONLY  
ABOUT BEAUTY, BUT  
ALSO ABOUT HUMANITY.  
RECONSTRUCT THE  
GOOD RELATIONSHIP  
BETWEEN PEOPLE AND  
THINGS, BUILD A LIFE  
ATTITUDE CONSISTENT  
WITH THE HEART,  
AND TELL THE STORY  
OF MODERN ART  
IN A RELAXED AND  
HUMOROUS WAY  
WITHOUT STUBBORN  
IDEAS AND BEING  
BOUND BY THINKING.





D1131L



Glass thickness 10mm  
玻璃厚度 10mm

Material Stainless steel  
材质 不锈钢

Color Mirror polish/Matte black/Brush gun grey/Brushed titanium  
颜色 镜光/雅黑/拉丝枪灰/拉丝钛金

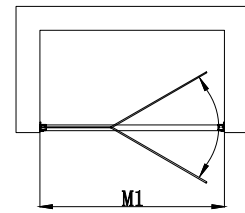
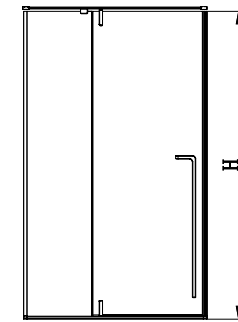

D1121L

Opening method	One-fixed-one-movable shaft (left inside and outside open)		
开门方式	一固一活转轴(左内外开)		
Standard of size	M1=1000	H=2100	
标准尺寸	宽1=1000	高=2100	
Size range	M1=900-1400	H=1900-2400	
定做范围	宽1=900-1400	高=1900-2400	

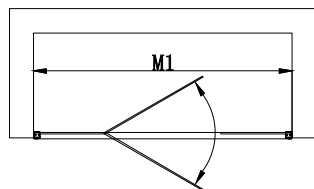
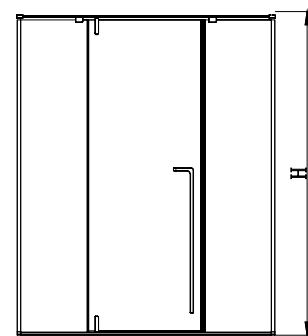

D1131L

Opening method	Two-fixed-one-movable shaft (left inside and outside open)		
开门方式	两固一活转轴(左内外开)		
Standard of size	M1=1500	H=2100	
标准尺寸	宽1=1500	高=2100	
Size range	M1=1200-2000	H=1900-2400	
定做范围	宽1=1200-2000	高=1900-2400	

Glass thickness 10mm  
玻璃厚度 10mm

Material Stainless steel  
材质 不锈钢

Color Mirror polish/Matte black/Brush gun grey/Brushed titanium  
颜色 镜光/雅黑/拉丝枪灰/拉丝钛金

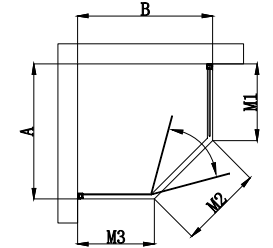
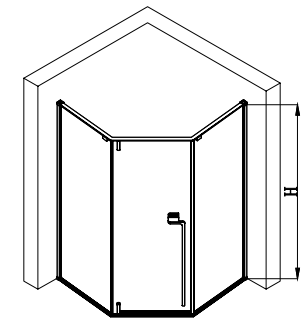

D1431L

Opening method	Diamond-shaped shaft (left inside and outside open)			
开门方式	钻石型转轴(左内外开)			
Standard of size	M1=550	M2=636	M3=550	H=2100
标准尺寸	宽1=550	宽2=636	宽3=550	高=2100
Size range	M1=200-1300	M2=500-900	M3=200-1300	H=1900-2400
定做范围	宽1=200-1300	宽2=500-900	宽3=200-1300	高=1900-2400

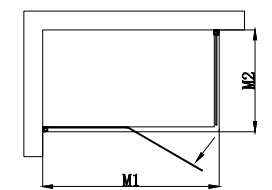
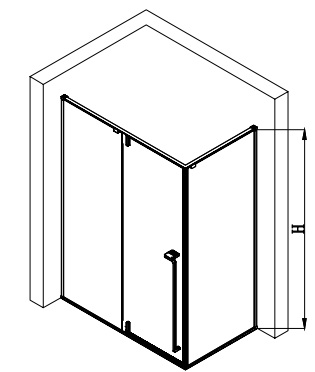

D1331L

Opening method	Rectangular shaft (left direction)		
开门方式	长方形转轴(左外开)		
Standard of size	M1=1200	M2=900	H=2100
标准尺寸	宽1=1200	宽2=900	高=2100
Size range	M1=1000-1600	M2=800-1300	H=1900-2400
定做范围	宽1=1000-1600	宽2=800-1300	高=1900-2400





# ULTIMATE PERFECTION

# C1 SERIES

**GERMAN** HEALTH  
BATHROOM.



C1132L



# C2 SERIES

**GERMAN** HEALTH BATHROOM.



HIGHLY PERSONALIZED, FASHION SENSE, SENSE OF SPACE, PERFECTLY REFLECTS THE SUBJECTIVITY OF MODERN YOUNG PEOPLE'S LIVING SPACE!

C2132L

C1

Glass thickness 10mm Material Stainless steel Color Mirror polish/Matte black/Brush gun grey  
 玻璃厚度 10mm 材质 不锈钢 颜色 镜光/雅黑/拉丝枪灰

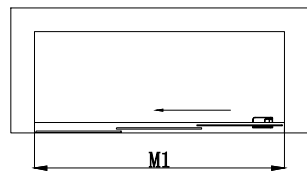
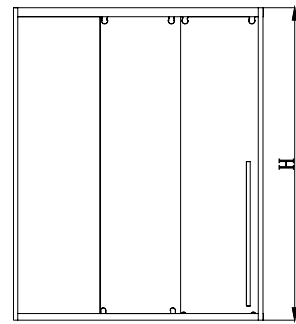

C1132L

Opening method	Linkage door (left direction)	
开门方式	联动门 (左方向)	
Standard of size	M1=1500	H=2000
标准尺寸	宽1=1500	高=2000
Size range	M1=1000-2500	H=1900-2200
定做范围	宽1=1000-2500	高=1900-2200

C2

Glass thickness 10mm Material Stainless steel Color Mirror polish/Matte black/Brush gun grey  
 玻璃厚度 10mm 材质 不锈钢 颜色 镜光/雅黑/拉丝枪灰

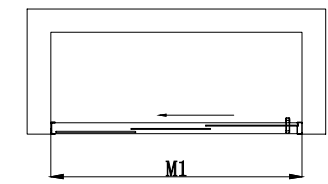
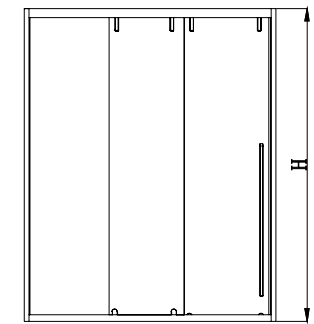

C2132L

Opening method	Linkage door (left direction)	
开门方式	联动门 (左方向)	
Standard of size	M1=1500	H=2000
标准尺寸	宽1=1500	高=2000
Size range	M1=1000-2500	H=1900-2200
定做范围	宽1=1000-2500	高=1900-2200

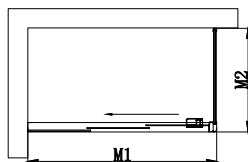
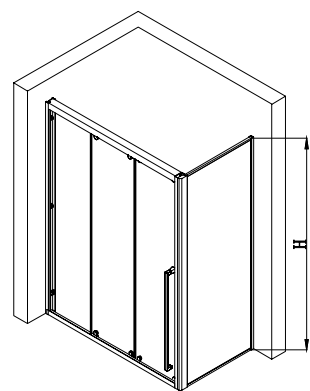

C1342L

Opening method	Rectangular linkage door (left direction)		
开门方式	长方形联动门 (左方向)		
Standard of size	M1=1400	M2=900	H=2000
标准尺寸	宽1=1400	宽2=900	高=2000
Size range	M1=1200-2500	M2=800-1300	H=1900-2200
定做范围	宽1=1200-2500	宽2=800-1300	高=1900-2200

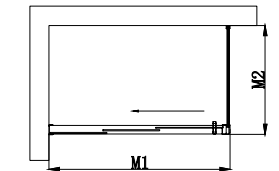
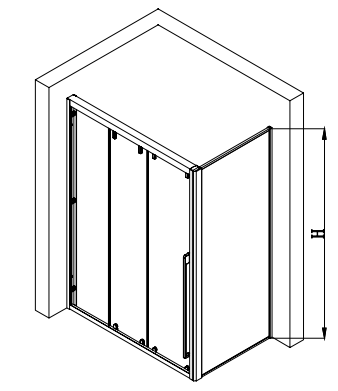

C2342L

Opening method	Rectangular linkage door (left direction)		
开门方式	长方形联动门 (左方向)		
Standard of size	M1=1400	M2=900	H=2000
标准尺寸	宽1=1400	宽2=900	高=2000
Size range	M1=1200-2500	M2=800-1300	H=1900-2200
定做范围	宽1=1200-2500	宽2=800-1300	高=1900-2200





# ROMANTIC AND WISDOM



# B1 SERIES

**GERMAN** HEALTH BATHROOM.



B1122





SIMPLE BUT NOT EXTREME, MODERN, ELEGANT BUT NOT SHOWY, SUITABLE FOR ANY BATHROOM.

B1332R

# B2 SERIES

**GERMAN** HEALTH BATHROOM

INNOVATIVE  
DESIGN

B2122



ETERNAL DESIGN NEVER PURSUES MEANINGLESS FASHION. ITS SHAPE MAKES IT A CONTEMPORARY CLASSIC.



B2332R

Glass thickness 10mm Material Stainless steel Color Mirror polish/Matte black/Brush gun grey  
 玻璃厚度 10mm 材质 不锈钢 颜色 镜光/雅黑/拉丝枪灰

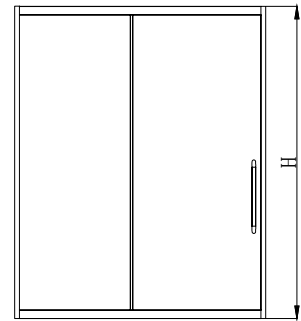

B1121L

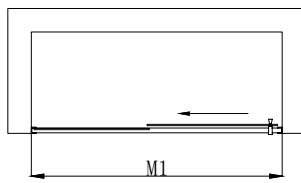

Opening method	One-fixed-one-movable single sliding door (left direction)	
开门方式	一固一活双移门 (左方向)	
Standard of size	M1=1500	H=2000
标准尺寸	宽1=1500	高=2000
Size range	M1=1200-1800	H=1900-2200
定做范围	宽1=1200-1800	高=1900-2200

Glass thickness 10mm Material Stainless steel Color Mirror polish/Matte black/Brush gun grey  
 玻璃厚度 10mm 材质 不锈钢 颜色 镜光/雅黑/拉丝枪灰

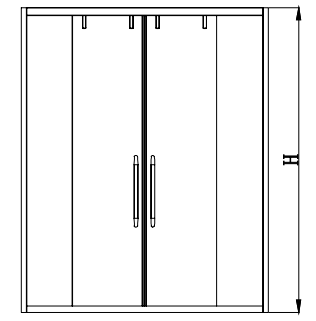

B1142

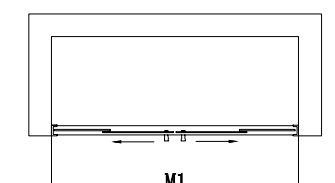

Opening method	Two-fixed-two-movable single sliding door	
开门方式	两固两活双移门	
Standard of size	M1=1600	H=2000
标准尺寸	宽1=1600	高=2000
Size range	M1=1500-2200	H=1900-2200
定做范围	宽1=1500-2200	高=1900-2200

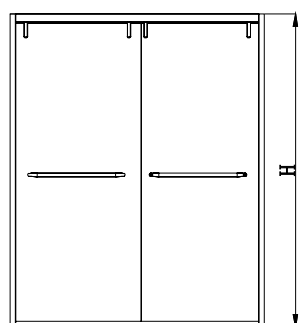

B1122

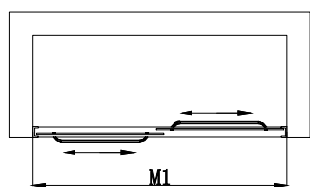

Opening method	Double sliding door	
开门方式	双移门	
Standard of size	M1=1500	H=2000
标准尺寸	宽1=1500	高=2000
Size range	M1=1200-1800	H=1900-2200
定做范围	宽1=1200-1800	高=1900-2200

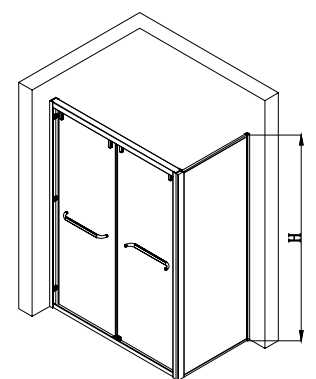

B1332L

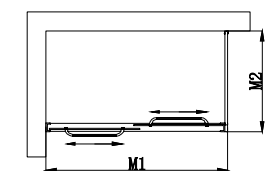

Opening method	Rectangular double sliding door (left direction)		
开门方式	长方形双移门 (左方向)		
Standard of size	M1=1400	M2=900	H=2000
标准尺寸	宽1=1400	宽2=900	高=2000
Size range	M1=1200-1800	M2=800-1300	H=1900-2200
定做范围	宽1=1200-1800	宽2=800-1300	高=1900-2200



Glass thickness 8mm 玻璃厚度 8mm  
 Material 8mm 材质 8mm  
 Stainless steel 不锈钢  
 Color 颜色  
 Mirror polish/Matte black/Brush gun grey 镜光/雅黑/拉丝枪灰

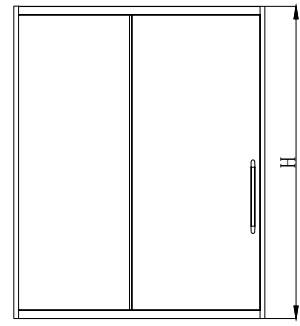

B2121L

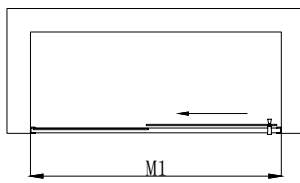

Opening method	One-fixed-one-movable single sliding door (left direction)	
开门方式	一固定一活双移门（左方向）	
Standard of size	M1=1500	H=2000
标准尺寸	宽1=1500	高=2000
Size range	M1=1200-1800	H=1900-2200
定做范围	宽1=1200-1800	高=1900-2200

Glass thickness 8mm 玻璃厚度 8mm  
 Material 8mm 材质 8mm  
 Stainless steel 不锈钢  
 Color 颜色  
 Mirror polish/Matte black/Brush gun grey 镜光/雅黑/拉丝枪灰

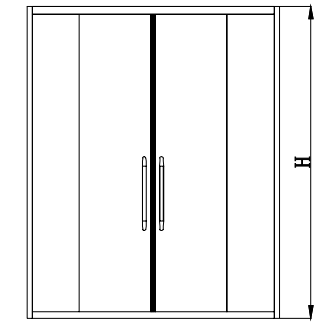

B2142

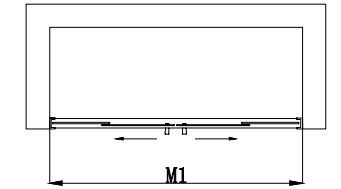

Opening method	Two-fixed-two-movable single sliding door	
开门方式	两固定两活双移门	
Standard of size	M1=1600	H=2000
标准尺寸	宽1=1600	高=2000
Size range	M1=1500-2200	H=1900-2200
定做范围	宽1=1500-2200	高=1900-2200

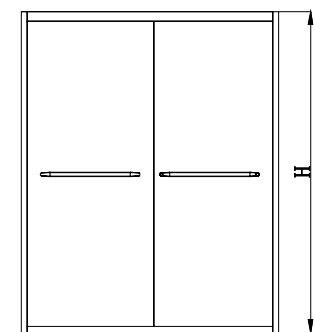

B2122

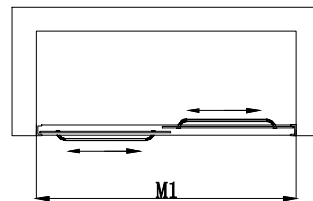

Opening method	Double sliding door	
开门方式	双移门	
Standard of size	M1=1500	H=2000
标准尺寸	宽1=1500	高=2000
Size range	M1=1200-1800	H=1900-2200
定做范围	宽1=1200-1800	高=1900-2200

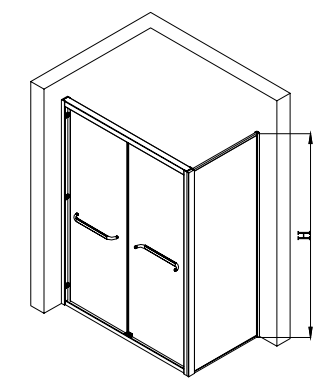

B2332L

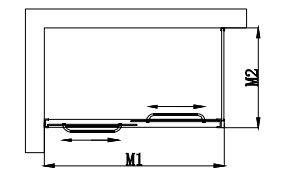

Opening method	Rectangular double sliding door (left direction)		
开门方式	长方形双移门（左方向）		
Standard of size	M1=1400	M2=900	H=2000
标准尺寸	宽1=1400	宽2=900	高=2000
Size range	M1=1200-1800	M2=800-1300	H=1900-2200
定做范围	宽1=1200-1800	宽2=800-1300	高=1900-2200

BRINGS  
YOU WITH  
NATURAL  
FEELING



# B3 SERIES

**GERMAN** HEALTH BATHROOM.



IT INHERITS THE TASTE AND ELEGANCE OF SIMPLE SPACE LAYOUT, AND MAKES THE SENSE OF PRODUCT HIERARCHY MORE IN LINE WITH THE AESTHETIC STANDARD OF MODERN SIMPLICITY.

**B3122**

Glass thickness 8mm 玻璃厚度 8mm  
 Material Aluminium alloy 材质 铝合金  
 Color Bright silver/Matte black/Brush gun grey 颜色 亮银/雅黑/拉丝枪灰

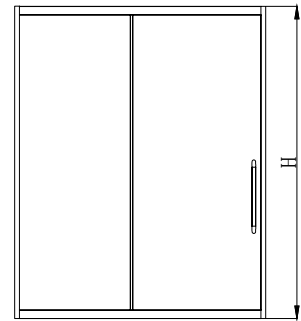

B3121L

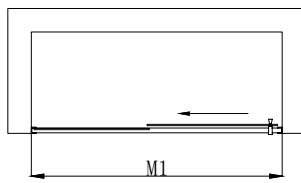

Opening method	One-fixed-one-movable single sliding door (left direction)	
开门方式	一固一活双移门 (左方向)	
Standard of size	M1=1500	H=2000
标准尺寸	宽1=1500	高=2000
Size range	M1=1200-1800	H=2000or2200
定做范围	宽1=1200-1800	高=2000或2200

Glass thickness 8mm 玻璃厚度 8mm  
 Material Aluminium alloy 材质 铝合金  
 Color Bright silver/Matte black/Brush gun grey 颜色 亮银/雅黑/拉丝枪灰

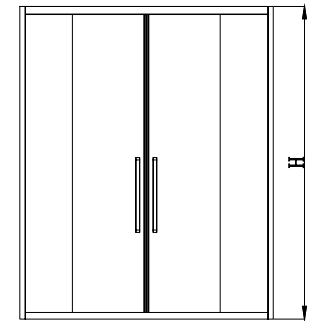

B3142

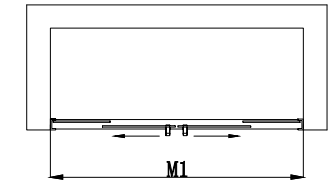

Opening method	Two-fixed-two-movable single sliding door	
开门方式	两固两活双移门	
Standard of size	M1=1600	H=2000
标准尺寸	宽1=1600	高=2000
Size range	M1=1500-2200	H=2000or2200
定做范围	宽1=1500-2200	高=2000或2200

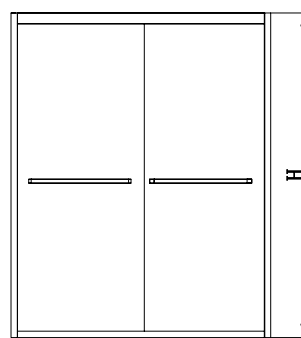

B3122

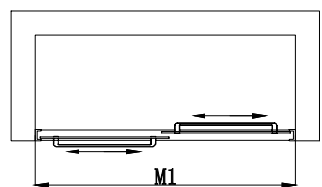

Opening method	Double sliding door	
开门方式	双移门	
Standard of size	M1=1500	H=2000
标准尺寸	宽1=1500	高=2000
Size range	M1=1200-1800	H=2000or2200
定做范围	宽1=1200-1800	高=2000或2200



# A1 SERIES

**GERMAN** HEALTH BATHROOM.



A1242

COMFORT AND NATURE COME FROM COUNTLESS TECHNICAL  
SUBLIMATION, SCIENCE AND AESTHETICS HARMONIOUSLY INTEGRATE, AND  
HEALTHY LIFE COMES FROM ULTIMATE PERFECTION.



A1331R



Glass thickness 8mm 玻璃厚度 8mm  
 Material 8mm 材质 不锈钢  
 Color Mirror polish/Matte black/Brush gun grey 颜色 镜光/雅黑/拉丝枪灰

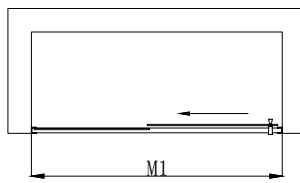
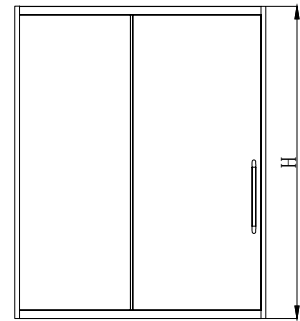

A1121L

Opening method	One-fixed-one-movable single sliding door (left direction)	
开门方式	一固定一活单移门 (左方向)	
Standard of size	M1=1500	H=2000
标准尺寸	宽1=1500	高=2000
Size range	M1=1200-1800	H=1900-2200
定做范围	宽1=1200-1800	高=1900-2200

Glass thickness 8mm 玻璃厚度 8mm  
 Material 8mm 材质 不锈钢  
 Color Mirror polish/Matte black/Brush gun grey 颜色 镜光/雅黑/拉丝枪灰

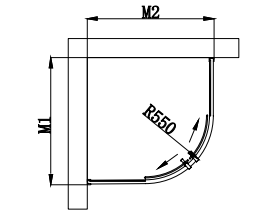
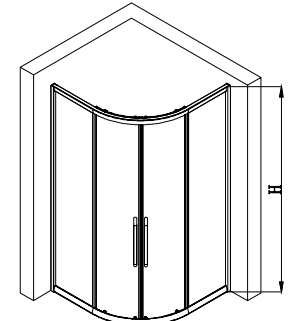

A1242

Opening method	Sector single sliding door (double door)		
开门方式	扇形单移门 (双开门)		
Standard of size	M1=1000	M2=1000	H=2000
标准尺寸	宽1=1000	宽2=1000	高=2000
Size range	M1=800-1300	M2=800-1300	H=2000 (高不能变)
定做范围	宽1=800-1300	宽2=800-1300	高=2000 (高不能变)

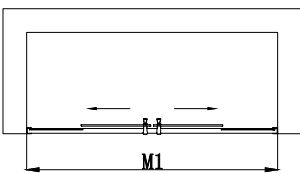
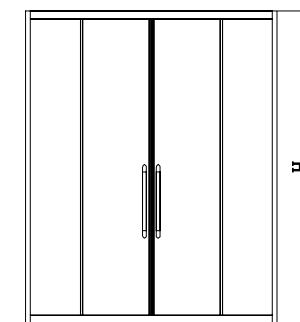

A1142

Opening method	Two-fixed-two-movable single sliding door (double door)	
开门方式	两固定两活单移门 (双开门)	
Standard of size	M1=1600	H=2000
标准尺寸	宽1=1600	高=2000
Size range	M1=1500-2200	H=1900-2200
定做范围	宽1=1500-2200	高=1900-2200

A1331L

Opening method	Rectangular single sliding door		
开门方式	长方形单移门		
Standard of size	M1=1400	M2=900	H=2000
标准尺寸	宽1=1400	宽2=900	高=2000
Size range	M1=1200-1800	M2=800-1300	H=1900-2200
定做范围	宽1=1200-1800	宽2=800-1300	高=1900-2200

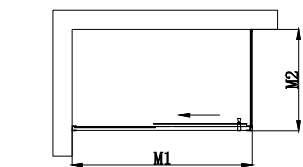
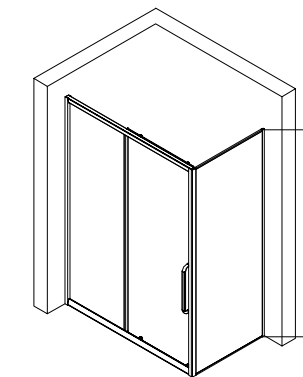



# ROMANTIC AND WISDOM



**A2** SERIES

**CALMNESS**

**GERMAN** HEALTH BATHROOM



Calmness is the only verve of life, living outstandingly, living with elegant rhythms, resplendent clean stream flows at home .

**A2242**



A2121L



Glass thickness 8mm 玻璃厚度 8mm  
 Material 8mm 材质 不锈钢  
 Color Mirror polish/Matte black/Brush gun grey 颜色 镜光/雅黑/拉丝枪灰

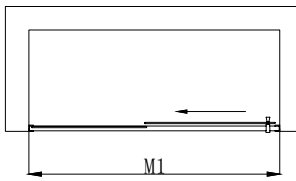
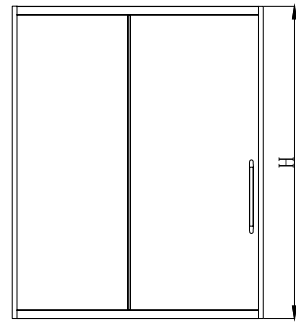

A2121L

Opening method	One-fixed-one-movable single sliding door (left direction)	
开门方式	一固定一活单移门 (左方向)	
Standard of size	M1=1500	H=2000
标准尺寸	宽1=1500	高=2000
Size range	M1=1200-1800	H=1900-2200
定做范围	宽1=1200-1800	高=1900-2200

Glass thickness 8mm 玻璃厚度 8mm  
 Material 8mm 材质 不锈钢  
 Color Mirror polish/Matte black/Brush gun grey 颜色 镜光/雅黑/拉丝枪灰

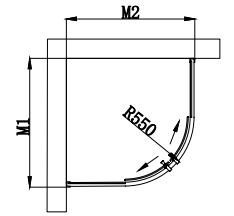
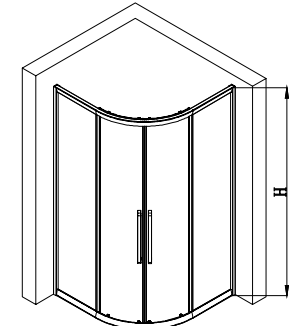

A2242

Opening method	Sector single sliding door (double door)		
开门方式	扇形单移门 (双开门)		
Standard of size	M1=1000	M2=1000	H=2000
标准尺寸	宽1=1000	宽2=1000	高=2000
Size range	M1=800-1300	M2=800-1300	H=2000 (高不能变)
定做范围	宽1=800-1300	宽2=800-1300	高=2000 (高不能变)

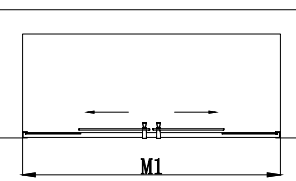
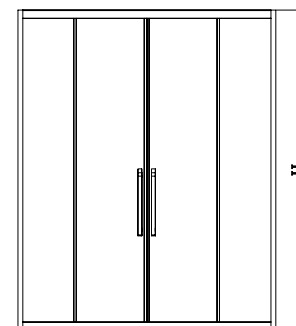

A2142

Opening method	Two-fixed-two-movable single sliding door (double door)	
开门方式	两固定两活单移门 (双开门)	
Standard of size	M1=1600	H=2000
标准尺寸	宽1=1600	高=2000
Size range	M1=1500-2200	H=1900-2200
定做范围	宽1=1500-2200	高=1900-2200

WE OFTEN DEFINE LUXURY, BUT THE REAL LUXURY IS TO SUPPORT THE GOOD CONNOTATION WITH HIGH-LEVEL APPEARANCE. NO ONE IS WILLING TO LOOK FOR YOUR INNER QUALITY FROM YOUR SLOPPY APPEARANCE", SO IS THE DESIGN OF THE SHOWER ROOM. BUT HERE, LIGHT LUXURY IS APPLIED TO THE EXTREME.





## 高斯淋浴房编码规则

### 第1位数代表开门方式

**A** Sliding door 单移门    **B** Double door 双移门    **C** Linkage door 联动门    **D** Shaft door 转轴门    **E** shaped door 合页门

### 第2位数代表款式

**1** First style 第一款式    **2** Second style 第二款式    **3** Third style 第三款式    **4** Fourth style 第四款式

### 第3位数代表淋浴房形状

**1** Zigzag screen 一字型屏风    **2** Sector 扇形    **3** Rectangular 长方型    **4** Diamond 钻石型

**T** Partition is added in the middle of the screen  
屏风中间加隔断

**E** Partition shall be added between the middle and both sides of the screen  
屏风中间与两侧加隔断

### 第7位数代表墙夹、边材可通款

**A** With wall clamp 配墙夹    **B** Sapwood 配边材

### 淋浴房的型号编码说明

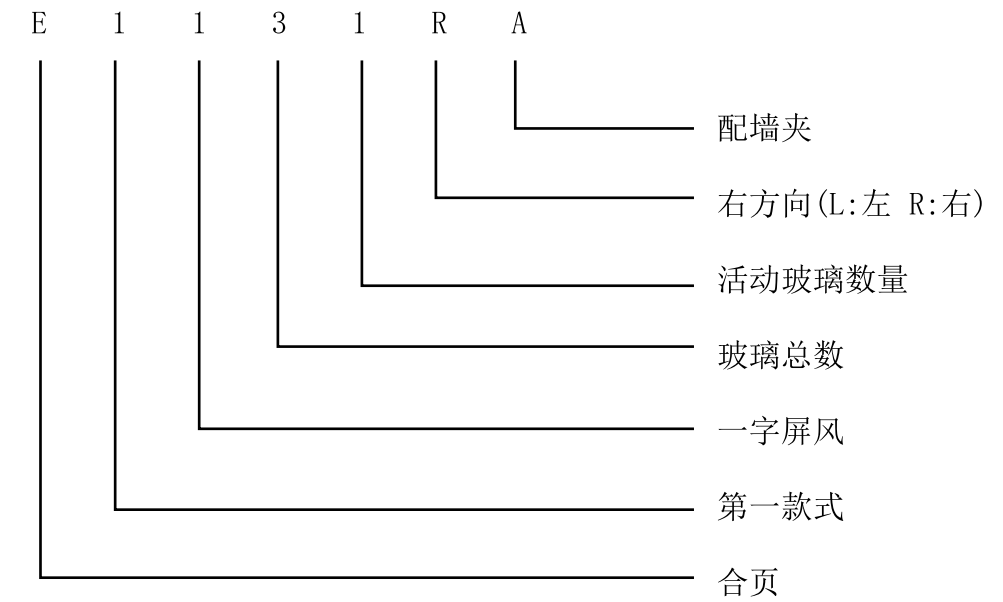

**COSO**<sup>®</sup>

**@2022 Copyright COSO Technologie Deutschland GmbH**



ZH-2022 The catalogue of **COSO** products is depended on the technological choices and the chromatic aberration that caused by the Table number: 88636488.99/26/3.9. Printed on Deutschland. Printed on the 100% anaerobic bleaching paper.

ZH-2022 德国 **COSO** 高斯产品目录·取决于技术选择和因印刷流程造成的色差  
表格编号 88636488.99/26/3.9. 在德国印制. 印制在 100% 无氯漂白纸张上